

Sample



COPPER DESIGN REVIEW COMMITTEE (CDRC) SIGN APPLICATION

Applicant Information

Applicant: Woodward Project: Barn Date: 09/01/2016

Address: P O Box 3001

Street Address *Unit #*

Copper Mountain Co 80443

City *State* *ZIP Code*

Phone: 970-968-2318 Email: aschriber@coppercolorado.com

Sign Information

Sign Type (Wall, Blade, etc.)	Dimensions			Sign Size (Area) / If Wall Sign: must Include Façade Area (See sign program, Page 12)	Sign Materials
	Height	Length	Width		
#1 Wall	34"	110"	1.5"	26 sq. ft. / 1,600 sq. ft.	Aluminum/ Acrylic Letters/ Vinyl
#2 Freestanding	24"	78"	1"	13 sq. ft. /	Aluminum/ Acrylic Letters/ Vinyl
#3 wall	74"	240"	5"	124 sq. ft. / 3,800 sq.ft.	Aluminum /Lexan
#4 Blade	21.5"	44"	1"	110 sq. ft. /	Aluminum /Pine/Acrylic

This application is to be attached to the Sign Submittal Drawings per page 3 and 4 of the Copper Mountain Sign Program, to include:

- Site (Proximity) Plan
- Elevation of building with proposed sign in place
- Detailed drawings of all exposed sides and edges, to include:
 - o Dimensions and Square Footage (S.F.) of each sign.
 - o Features, including all 3-D elements, such as: raised lettering, layering of materials, etc.
 - o Materials – labeled
 - o Colors - labeled
 - o All lettering
 - o Brackets – How will the sign be attached to the bracket and how will the bracket be attached to the building.
 - o Lighting – Indicate type with visual representation of where fixture is to be placed if external lighting is use.

Illumination: Yes No If yes, submit cut-sheet of light source with application.

CDRC Recommendation for Approval (Office Use only)

Approved Approved With Conditions (See Attached) Denied (See Attached)

Summit County Permit Required Yes No

CDRC _____ Title: _____ Date: _____

Copper Mountain Resort Association
 Office: 970 968-6477
 Fax: 970 968-2187
 800 Copper Road, # 3053
 0189 Ten Mile Circle, Suite 116
 Copper Mountain, Co. 80443



Barn Sign Proposal

Updating Logos on signage to match current Woodward Copper brand guidelines under new Sign Code.

Aerial view of locations

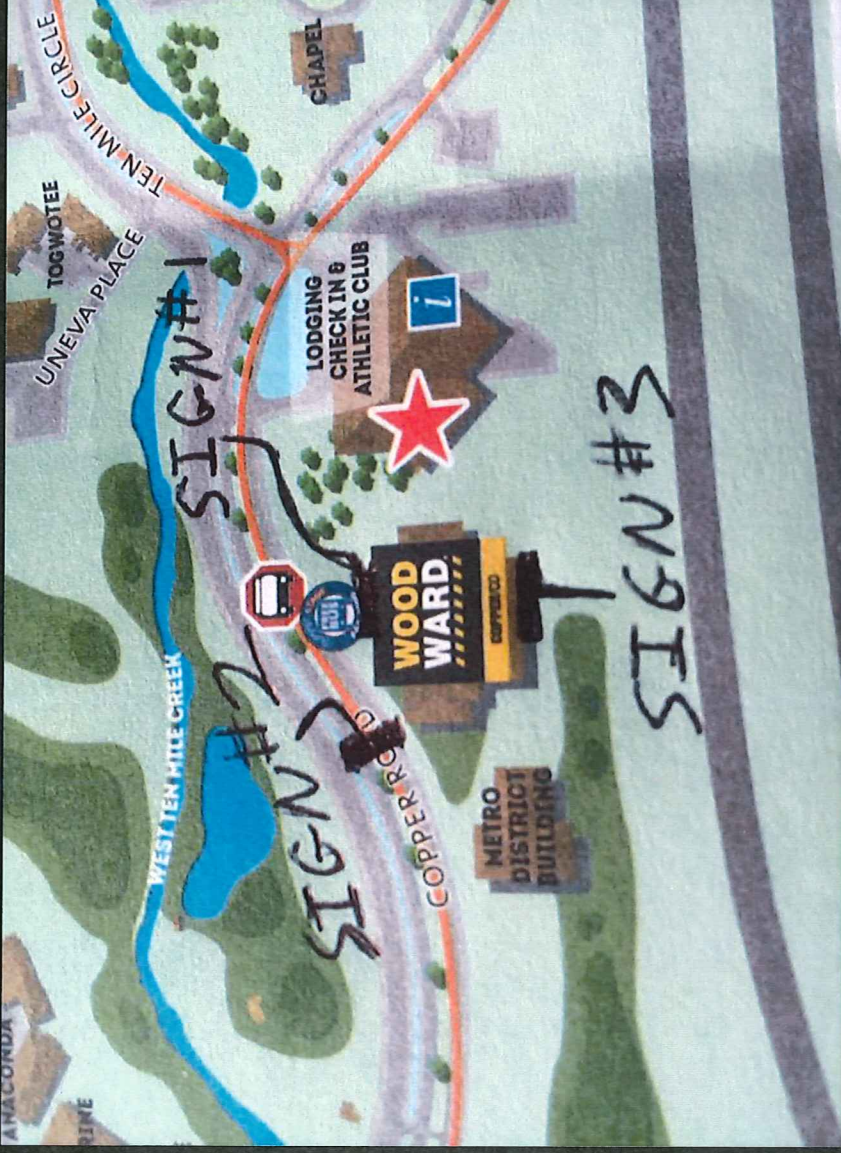

- Sign # 1 - is 1 sided sign mounted on the Barn building above the front door of the Barn facing the mountain (south facing).
- Sign # 2 - is a 2 sided freestanding sign just off of Copper Road facing east and west.
- Sign #3 - is a 1 sided sign mounted on the back of the Barn building facing I-70 (north facing).



Barn Sign #1



CLIENT: Copper JOB NUMBER: _____
 DATE: 6/14/2016 FILE NAME: Copper Woodward Exterior Building ID Working
 ARTWORK BY: Jonathan PHONE: 970-949-4566

© This document and all of its contents are the exclusive property of Sign Design and Awnings, under US copyright laws. The use of this document is strictly intended for design approval.



Sign 1

Building Facade Area 30' x 53' = 1,600 sq. ft. Sign Area 34" x 110" = 26 sq. ft.

APPROVED FOR PRODUCTION BY: _____ DATE: _____



CLIENT: Copper
 DATE: 6/14/2016
 ARTWORK BY: Jonathan

JOB NUMBER:
 FILE NAME: Copper Woodward Exterior Building ID Working
 PHONE: 970-949-4565

© This document and all of its contents are the exclusive property of Sign Design and Awnings, under US copyright laws. The use of this document is strictly intended for design approval.

Sign 1



- A - 1 1/2" x 1 1/2" Aluminum square tube frame painted PMS 000 yellow
 - B - 1/8" Aluminum backer panel painted MAP black
 - C - 1/2" Acrylic letters mounted with tape and adhesive painted PMS 000 yellow and MAP white
 - D - Vinyl to match yellow
 - E - 1 1/2" x 1 1/2" Aluminum angle mounting bracket mechanically fastened to building; sign is mechanically fastened to mounting bracket
- 34" x 110" = 26 sq. ft.



Barn Sign #2



CLIENT: Copper JOB NUMBER:
 DATE: 6/14/2016 FILE NAME: Copper Woodward Exterior Building ID Working
 ARTWORK BY: Jonathan PHONE: 970-949-4565

© This document and all of its contents are the exclusive property of Sign Design and Awnings, under US copyright laws. The use of this document is strictly intended for design approval.

Sign 2
 Option 1

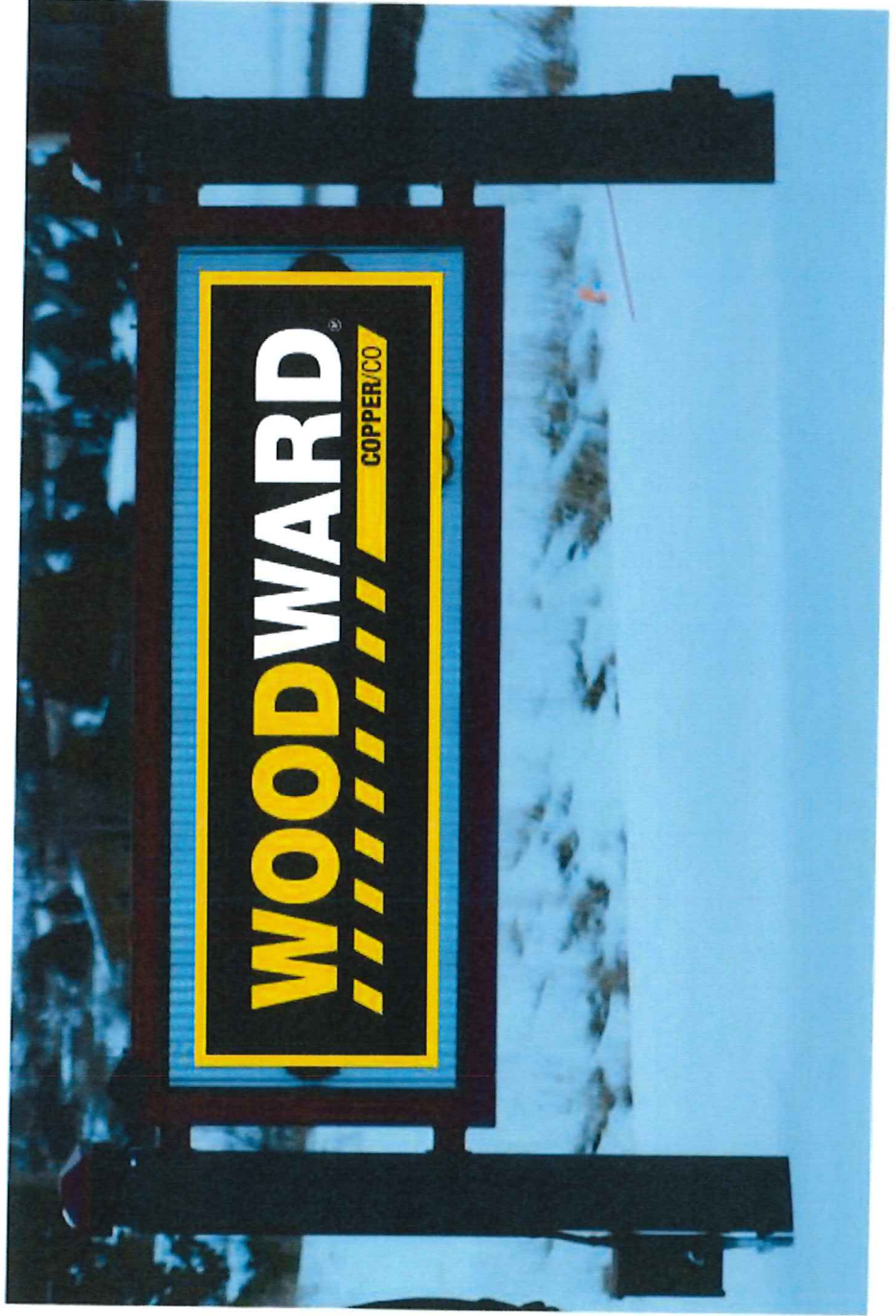



Barn Sign #2



CLIENT: Copper JOB NUMBER:
 DATE: 6/14/2016 FILE NAME: Copper Woodward Exterior Building ID Working
 ARTWORK BY: Jonathan PHONE: 970-949-4565

© This document and all of its contents are the exclusive property of Sign Design and Awnings, under US copyright laws. The use of this document is strictly intended for design approval.

Sign 2
Option 1

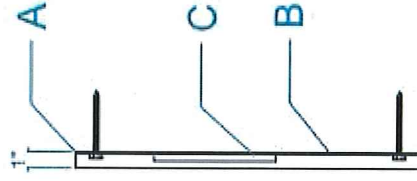
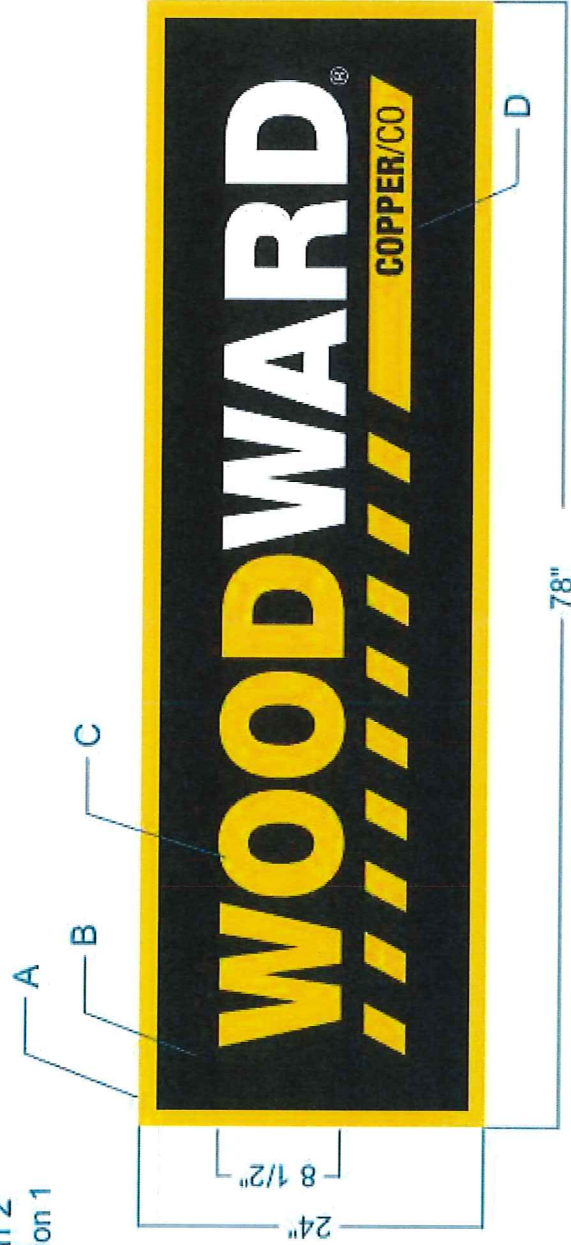

New sign on existing sign frame

A - 1" x 1" Aluminum square tube frame painted PMS 000 yellow

B - 1/8" Aluminum backer panel painted MAP black

C - 1/2" Acrylic letters mounted with tape and adhesive painted PMS 000 yellow and MAP white

D - Vinyl to match yellow

New sign panel is mechanically fastened to existing sign frame

24" x 78" = 13 sq. ft.



Barn Sign #3



CLIENT: Copper
 DATE: 6/14/2016
 ARTWORK BY: Jonathan

JOB NUMBER:

FILE NAME: Copper Woodward Exterior Building ID Working
 PHONE: 970-949-4565

© This document and all of its contents are the exclusive property of Sign Design and Awnings, under US copyright laws. The use of this document is strictly intended for design approval.

Sign 3

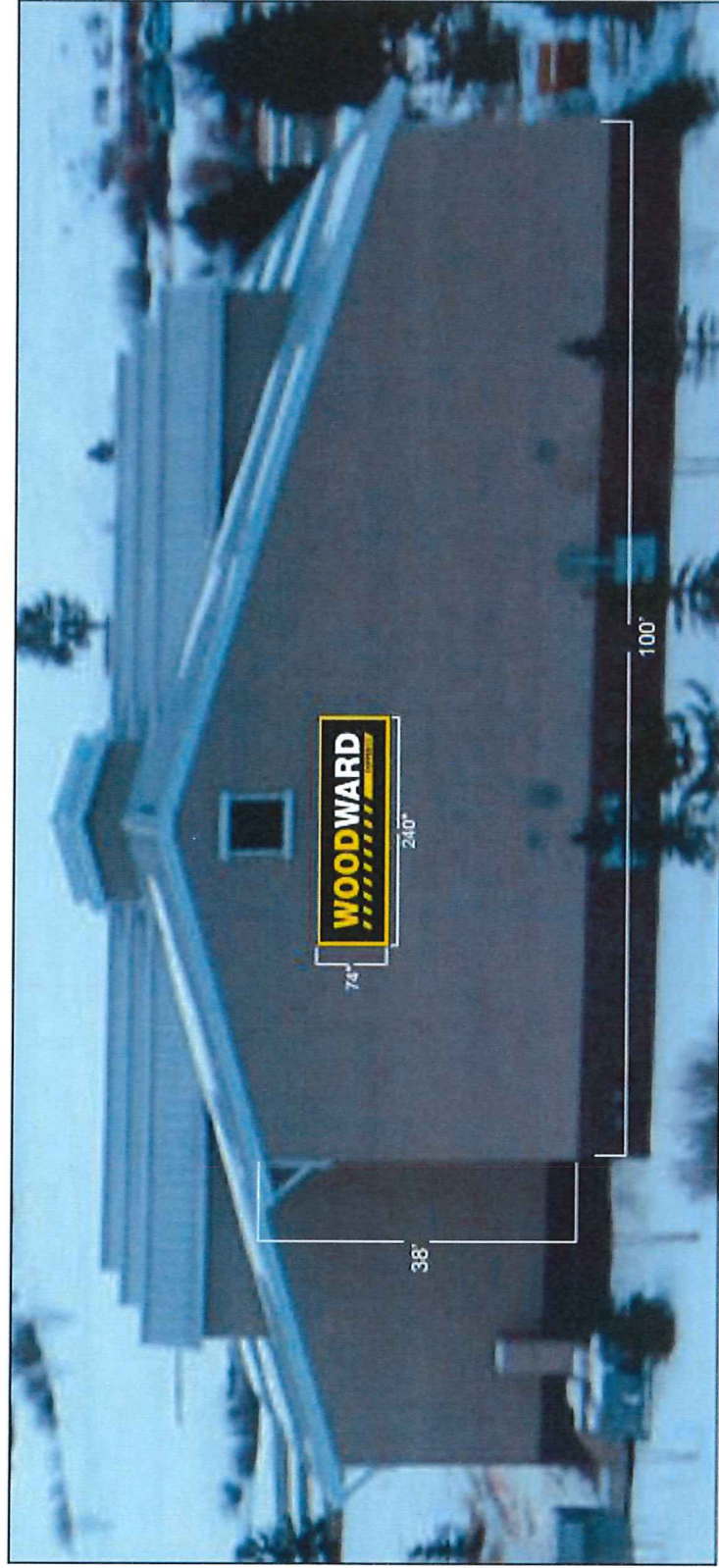

Building Facade Area 38' x 100' = 3,800 sq. ft. Sign Area 34" x 110" = 124 sq. ft.



Barn Sign #3



CLIENT: Copper JOB NUMBER:
 DATE: 6/14/2016 FILE NAME: Copper Woodward Exterior Building ID Working
 ARTWORK BY: Jonathan PHONE: 970-949-4565

© This document and all of its contents are the exclusive property of Sign Design and Awnings, under US copyright laws. The use of this document is strictly intended for design approval.

Sign 3

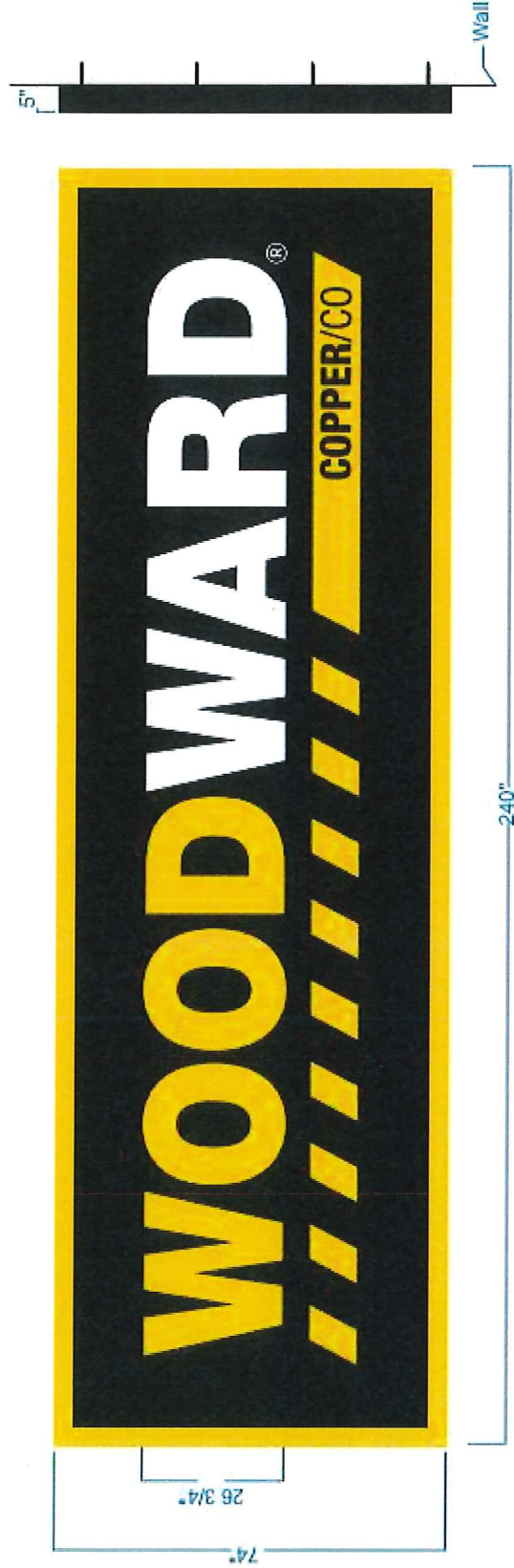

5" deep aluminum cabinet box, painted black, 1/8" white lexan face with exterior translucent digital graphics and laminate; face illuminates with white led lights







Cabinet box is mechanically fastened to building through the back of the sign
 74" x 240" = 124 sq. ft.





Lights



HanleyLED SOLUTIONS

Product Name	LED Power Supply/Driver		
Model	H100W-PPS277		
			
Safety Certification	 	 	

HanleyLED SOLUTIONS

Product Name	LED Module - Peregrine Series		
Model	P-2072		
			
			



Mounting Hardware



Zinc-Plated Steel Toggle Bolt
Round Head, 1/2" Diameter, 6" Length

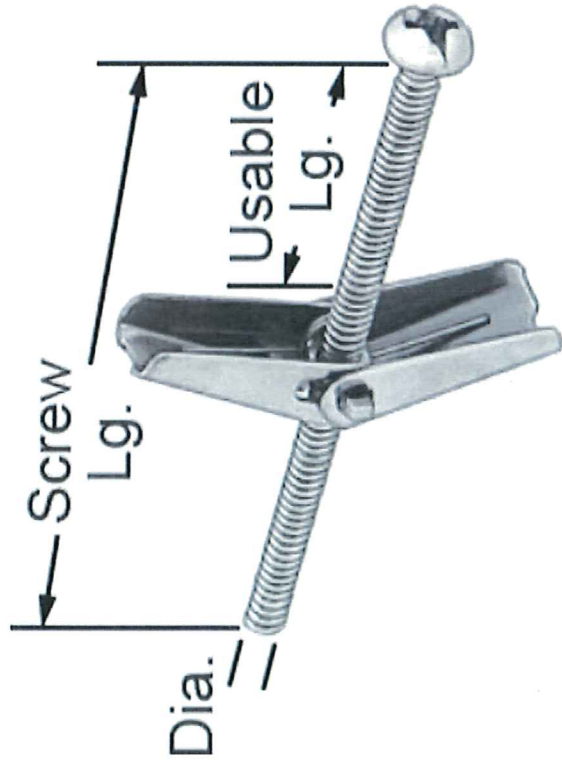

Steel, Stainless &
Hot-Dip Galvanized

Lag Screws Bolts & Cap Screws

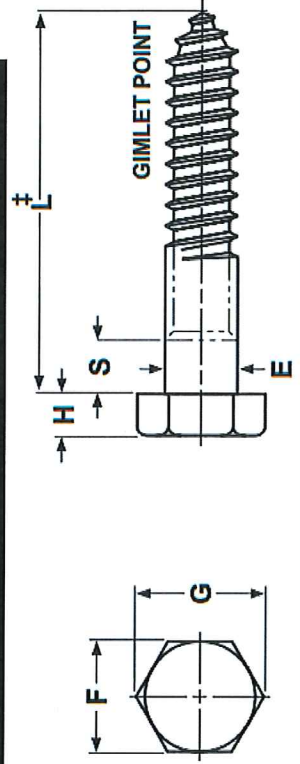

Sign #4 - Blade Sign

62007

21.5"x44" custom routed/built hanging blade sign [x1]

Core layer = unfinished aluminum/steel to allow for natural aging

Base layer = custom routed Local Grey Stained Pine Lumber

Logo layer = stand-off 1/4" P-95 (Frosted) Acrylic panel w/ painted dimensional logo



Sign

Area110sf



Side View

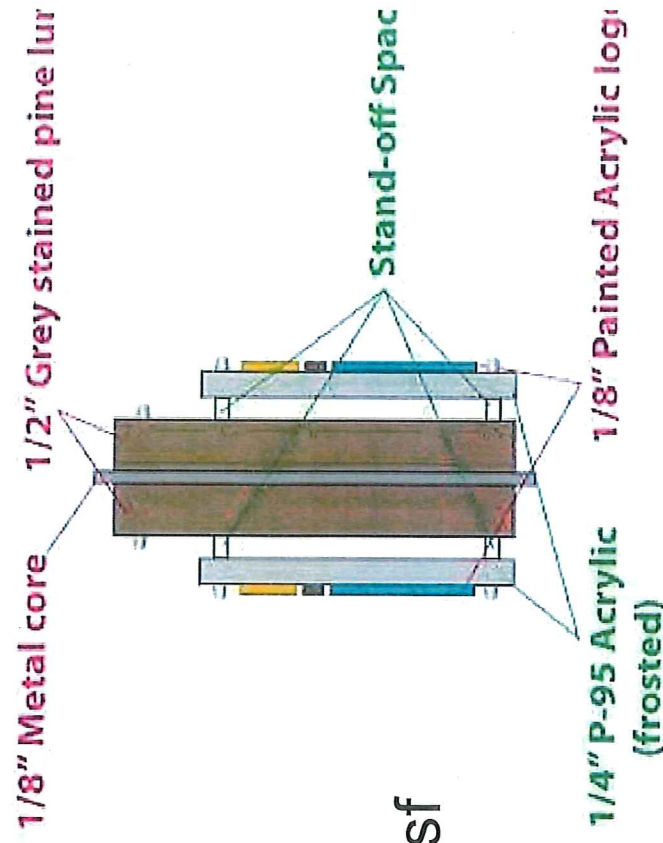

Sales: Joe | Design: Caleb